



# DS 202

## Electronic Pressure Switch

welded, dry Stainless Steel Sensor

accuracy according to IEC 60770:  
0.5 % FSO

### Nominal pressure

from 0 ... 6 bar up to 0 ... 600 bar

### Contacts

1, 2 or 4 independent PNP contacts,  
freely configurable

### Analogue output

2-wire: 4 ... 20 mA  
3-wire: 4 ... 20 mA / 0 ... 10 V  
others on request

### Special characteristics

- ▶ indication of measured values on a 4-digit LED display
- ▶ rotatable and configurable display module

### Optional versions

- ▶ **IS-version**  
**Ex ia = intrinsically safe for gases**
- ▶ oxygen application
- ▶ customer specific versions





The electronic pressure switch DS 202 is the successful combination of

- ▶ robust pressure transmitter
- ▶ digital display

and has been specially designed for numerous applications in various industrial sectors.

As standard the DS 202 offers a PNP contact and a rotatable display module with 4-digit LED display. The transmitters are suitable for an unrestricted use in oxygen applications up to 600 bar and an intrinsically safe IS-Version.

### Preferred areas of use are

-  Medical Technology
-  Plant and Machine Engineering
-  Refrigeration
-  Oxygen application



Input pressure range												
Nominal pressure gauge	[bar]	6	10	16	25	40	60	100	160	250	400	600
Overpressure	[bar]	14	35	35	70	140	140	350	350	700	1200	1200
Burst pressure $\geq$	[bar]	35	85	85	175	350	350	850	850	1750	2800	2800
Vacuum resistance		unlimited										
Contact <sup>1</sup>												
Number, type		standard: 1 PNP contact option: 2 independent PNP contacts 4 independent PNP contacts (possible with M12x1 8-pin for 4 ... 20 mA / 3-wire)										
Max. switching current		4 ... 20 mA / 2- and 3-wire: contact rating 125 mA, short-circuit resistant; $V_{switch} = V_S - 2V$ 0 ... 10 V / 3-wire: contact rating 500 mA, short-circuit resistant										
Accuracy of contacts <sup>2</sup>		$\leq \pm 0.5\%$ FSO										
Repeatability		$\leq \pm 0.1\%$ FSO										
Switching frequency		max. 10 Hz										
Switching cycles		$> 100 \times 10^6$										
Delay time		0 ... 100 sec										
<sup>1</sup> with IS-protection max. 1 contact possible												
Analogue output (optionally) / Supply												
2-wire current signal		4 ... 20 mA / $V_S = 13 \dots 36 V_{DC}$ permissible load: $R_{max} = [(V_S - V_{Smin}) / 0.02 A] \Omega$ response time: $< 10$ msec										
2-wire current signal with IS-protection		4 ... 20 mA / $V_S = 13 \dots 28 V_{DC}$ permissible load: $R_{max} = [(V_S - V_{Smin}) / 0.02 A] \Omega$ response time: $< 10$ msec										
3-wire current signal		4 ... 20 mA / $V_S = 19 \dots 30 V_{DC}$ permissible load: $R_{max} = 500 k\Omega$ adjustable (turn-down of span up to 1:5) <sup>3</sup>										
3-wire voltage signal		0 ... 10 V / $V_S = 15 \dots 36 V_{DC}$ permissible load: $R_{min} = 10 k\Omega$										
without analogue output		$V_S = 15 \dots 36 V_{DC}$										
Accuracy <sup>2</sup>		$\leq \pm 0.5\%$ FSO										
<sup>2</sup> accuracy according to IEC 60770 – limit point adjustment (non-linearity, hysteresis, repeatability)												
<sup>3</sup> with turn-down of span the analogue signal is adjusted automatically to the new measuring range												
Thermal effects (Offset and Span)												
Thermal error		$\pm 0.3\%$ FSO / 10 K										
in compensated range		0 ... 70 °C										
Permissible temperatures												
Permissible temperatures		medium: -40 ... 125 °C electronics / environment: -40 ... 85 °C storage: -40 ... 100 °C										
Electrical protection												
Short-circuit protection		permanent										
Reverse polarity protection		no damage, but also no function										
Electromagnetic compatibility		emission and immunity according to EN 61326										
Mechanical stability												
Vibration		10 g RMS (25 ... 2000 Hz) according to DIN EN 60068-2-6										
Shock		500 g / 1 msec according to DIN EN 60068-2-27										
Materials												
Pressure port		stainless steel 1.4571 (316 Ti)										
Housing		stainless steel 1.4404 (316 L)										
Display housing		PA 6.6, polycarbonate										
Seals (media wetted)		none (welded)										
Diaphragm		stainless steel 1.4542 (17-4PH)										
Media wetted parts		pressure port, diaphragm										
Explosion protection (only for 4 ... 20 mA / 2-wire)												
Approval AX14-DS 202		IBExU 06 ATEX 1050 X Zone 1: II 2G Ex ia IIC T4 Gb (connector) / II 2G Ex ia IIB T4 Gb (cable)										
Safety technical maximum values		$U_i = 28 V$ , $I_i = 93 mA$ , $P_i = 660 mW$ , $C_i \approx 0 nF$ , $L_i \approx 0 \mu H$										
Max. switching current <sup>4</sup>		70 mA (max. permissible inductivity: 4.7 mH)										
Permissible temperatures for environment		-20 ... 70 °C										
Connecting cables (by factory)		cable capacitance: signal line/shield also signal line/signal line: 160 pF/m cable inductance: signal line/shield also signal line/signal line: 1 $\mu H/m$										
<sup>4</sup> the real switching current in the application depends on the power supply unit												

Miscellaneous	
Display	4-digit, red 7-segment-LED display, digit height 7 mm, digit width 4.85 mm (angle 10°); range of indication -1999 ... +9999; accuracy 0.1 % ± 1 digit; digital damping 0.3 ... 30 sec (programmable); measured value update 0.0 ... 10 sec (programmable)
Current consumption (without contacts)	2-wire signal output current: max. 25 mA 3-wire signal output current: approx. 45 mA + signal current 3-wire signal output voltage: approx. 45 mA
Ingress protection	IP 65
Installation position	any
Weight	min. 160 g (depending on mechanical connection)
CE-conformity	EMC Directive: 2004/108/EC Pressure Equipment Directive: 97/23/EC (module A) <sup>5</sup>

<sup>5</sup> This directive is only valid for devices with maximum permissible overpressure > 200 bar

### Wiring diagrams

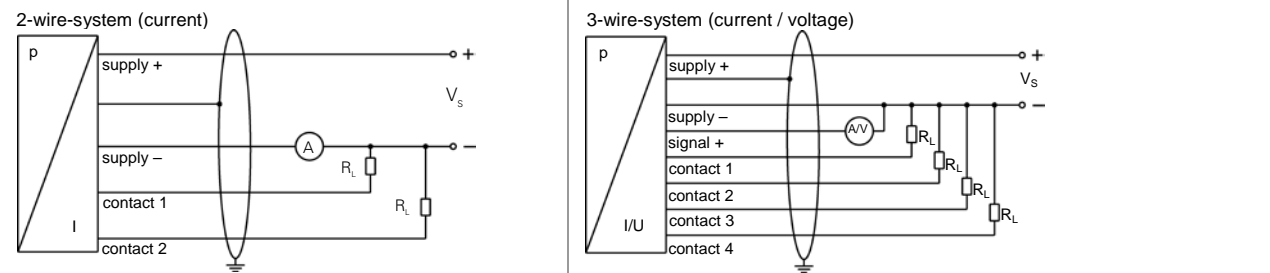

### Pin configuration

Electrical connection	M12x1 plastic (5-pin)	M12x1 metal (5-pin)	M12x1 plastic (8-pin)	ISO 4400	cable colours (DIN 47100)
Supply +	1	1	1	1	wh (white)
Supply -	3	3	3	2	bn (brown)
Signal + (only 3-wire)	2	2	2	3	gn (green)
Contact 1	4	4	4	3	gy (grey)
Contact 2	5	5	5	-	pk (pink)
Contact 3	-	-	6	-	-
Contact 4	-	-	7	-	-
Shield	via pressure port	plug housing / pressure port	via pressure port	ground contact	ye/gn (yellow/green)

### Electrical connections (dimensions in mm)

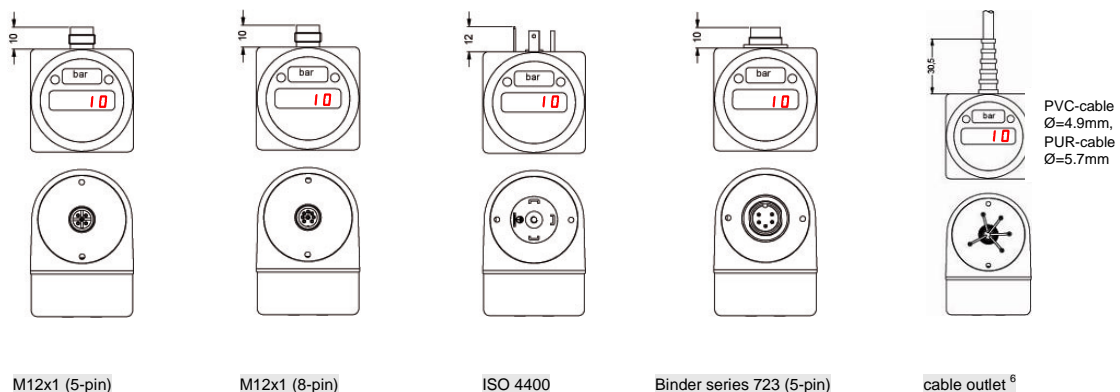

<sup>6</sup> different cable types and lengths available, permissible temperature depends on kind of cable; standard: 2 m PVC cable (without ventilation tube, permissible temperature: -5 ... 70 °C)

**Mechanical connections (dimensions in mm)**

**standard**

**option**

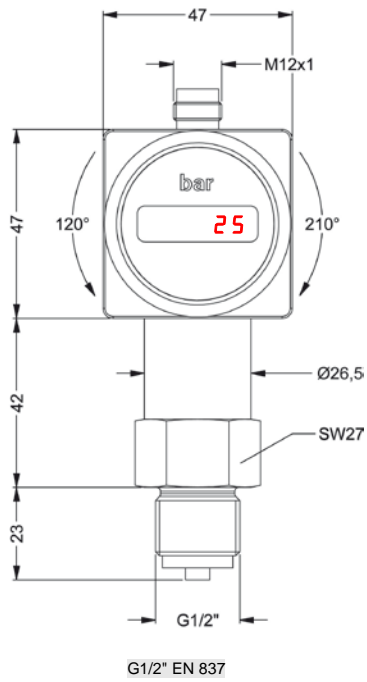

G1/2" EN 837

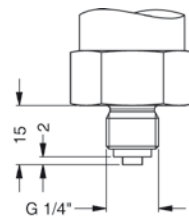

G1/4" EN 837

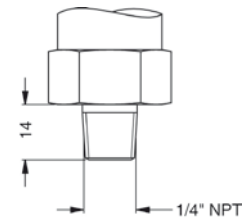

1/4" NPT

⇨ **metric threads and other versions on request**

This data sheet contains product specification, properties are not guaranteed. Subject to change without notice.

