

FEATURES

- Field-Bus remote data acquisition
- RS-485 Master/Slave communication type
- MODBUS RTU/ASCII protocol
- 1 universal analog input configurable for mV, V, mA, Tc, RTD, Res
- 1 digital input + 2 NPN digital output
- Watch-Dog alarm
- Remotely configurable
- 2000 Vac 3-way Galvanic Isolation
- High Accuracy
- EMC compliance – CE mark
- Suitable for DIN rail mounting in compliance with EN-50022

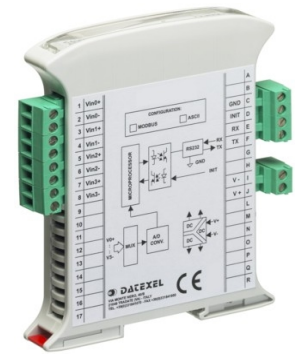

GENERAL DESCRIPTION

The device DAT 3010 converts the analog signal applied on the input in engineering units in digital format. The data are transmitted by the MODBUS RTU/ASCII protocol on RS-485. It is possible to connect on input RTD sensor, resistance, thermocouples, voltage signal up to ± 10 V and current up to ± 20 mA. Moreover one digital input and two digital output are available.

By means of a 16 bit converter, the device guarantees a high accuracy and a stable measure versus time and temperature.

To assure safe operation of the plant, the device is equipped with two Watch-Dog timers: in case of alarm, the outputs are forced automatically on the safe configuration. The digital outputs can also be used as trip alarms of the input analog signal.

The 2000 Vac isolation between input, power supply and RS-485 removes eventual ground-loop effects, allowing the use of the device even in the heavy environmental conditions.

The DAT 3010 is in compliance with the Directive 2004/108/EC on the electromagnetic compatibility.

The device is housed in a rough self-extinguishing plastic container which, thanks to its thin profile of 17.5mm only, allows a high density mounting on EN-50022 standard DIN rail.

COMMUNICATION PROTOCOLS

The DAT3010 is designed to work with the MODBUS RTU/ASCII protocol: standard protocol in field-bus; allows to directly interface DAT3000 series devices to the larger part of PLCs and SCADA applications available on the market.

For the protocol instructions, see the relative User Guide.

USER INSTRUCTIONS

Before to install the device, please read the "Installation Instruction" section.

If the module configuration is unknown, it can be hardly to establish a communication with it; connecting the INIT terminal to the GND terminal (ground), at the next power-up the device will be auto-configured in the default settings (see Operating User Guide).

Connect power supply, serial bus and analog input as shown in the "Wiring" section.

The "PWR" LED state depends to the working condition of the device: see the "Light Signalling" section to verify the device working state.

To perform configuration and calibration operations, read the instructions in the Operating User Guide.

To simplify handling or replacing of the device, it is possible to remove the wired terminals even with the device powered.

TECHNICAL SPECIFICATIONS (Typical @ 25 °C and in the nominal conditions)

Input type	Min	Max	Input Calibration (1)	Sample time	300 ms		
TC J K S R B E T N	-200°C	1200°C	RTD 100 Ω ±0.05 % f.s.	Data Transmission Baud Rate Max. distance	38.4 Kbps 1.2 Km		
	-200°C	1370°C	RTD 1000 Ω ±0.1 % f.s.				
	-50°C	1760°C	Res. 500 Ω ±0.1 % f.s.				
	-50°C	1760°C	Res. 2000 Ω ±0.2 % f.s.	Warm-up time	3 min.		
	400°C	1820°C	mV, TC > of ±0.05 % f.s. or ±5uV				
	-200°C	1000°C	Volt ±0.05 % f.s.				
	-200°C	400°C	mA ±0.05 % f.s.				
	-200°C	1300°C	Input impedance TC, mV >= 10 MΩ Volt >= 1 MΩ Current ~ 47 Ω	Power Supply Supply Voltage Current consumption Polarity inversion protection	10 .. 30 Vdc 40 mA @ 24 Vdc 60 Vdc max		
	RTD 2,3,4 wires Pt100 Pt1000 Ni100 Ni1000	-200°C -200°C -60°C -60°C	850°C 200°C 180°C 150°C		Linearity (1) TC ± 0.2 % f.s. RTD ± 0.1 % f.s.	Isolation Input – RS485 Supply – Input Supply – RS485	2000 Vac 50 Hz, 1 min. 2000 Vac 50 Hz, 1 min. 2000 Vac 50 Hz, 1 min.
	Voltage mV mV mV mV V	-50 mV -100 mV -250 mV -1000 mV - 10 V	+50 mV +100 mV +250 mV +1000mV +10 V		Lead wire resistance influence (1) TC, mV,V <=0.8 uV/Ohm RTD/res.3 wires 0.05 %/Ω (50 Ω max balanced) RTD/res. 4 wires 0.005 %/Ω (100 Ω max balanced)		Temperature & Humidity Operating temperature Storage temperature Humidity (non condensing)
RES. 2,3,4 wires Low High	0 Ω 0 Ω	500 Ω 2000 Ω	CJC comp. ± 0.5°C	Housing Material Mounting Weight	Self-extinguishing plastic DIN rail in compliance with EN 50022 ~ 150 g.		
Current mA	-20 mA	+20 mA	RTD excitation current Typical 0.350 mA		EMC (for industrial environments) Immunity Emission	EN 61000-6-2 EN 61000-6-4	
Digital input Logic level 0 Logic level 1 Impedance	0 V 3.5 V	+ 1 V + 30 V	Thermal drift (1) Full scale ± 0.01 % / °C CJC ± 0.02°C / °C			(1) Referred to input Span (difference between max. and min. values)	
	10 KΩ		Digital outputs (2 channels) Open Collector 30 V with max. load at 30 mA Power dissipation 0.3 W				

INSTALLATION INSTRUCTIONS

The DAT 3010 device is suitable for fitting to DIN rails in the vertical position. For optimum operation and long life follow these instructions:

When the devices are installed side by side it may be necessary to separate them by at least 5 mm in the following case:

- If panel temperature exceeds 45°C and high power supply value (> 27 Vdc)

Make sure that sufficient air flow is provided for the device avoiding to place raceways or other objects which could obstruct the ventilation slits. Moreover it is suggested to avoid that devices are mounted above appliances generating heat; their ideal place should be in the lower part of the panel. Install the device in a place without vibrations.

Moreover it is suggested to avoid routing conductors near power signal cables (motors, induction ovens, inverters etc...) and to use shielded cable for connecting signals.

CABLING

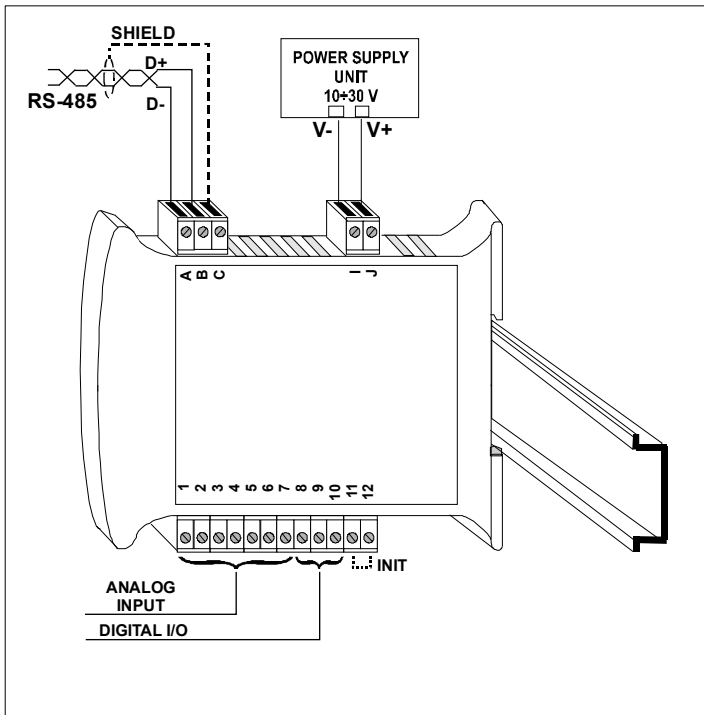

LIGHT SIGNALLING

LED	COLOUR	STATE	DESCRIPTION
PWR	GREEN	ON	Device powered
		OFF	Device not powered / Wrong RS-485 cabling.
		FAST BLINK	Communication in progress (blink frequency depends to baud-rate)
		1 second BLINK	Watch-Dog Alarm condition

DIMENSIONS (mm)

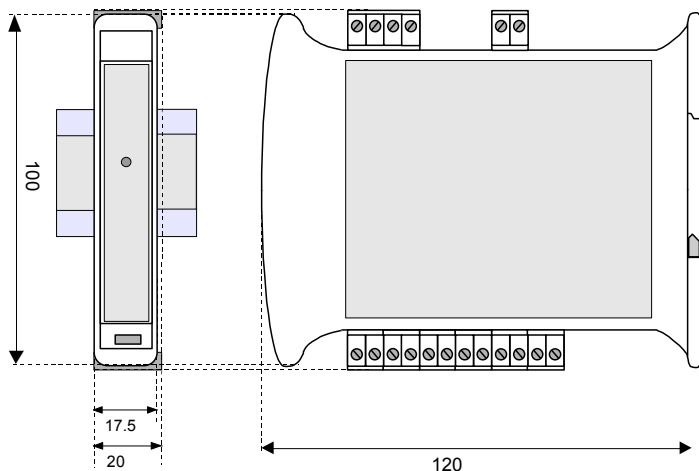

WIRING

I/O CONNECTIONS

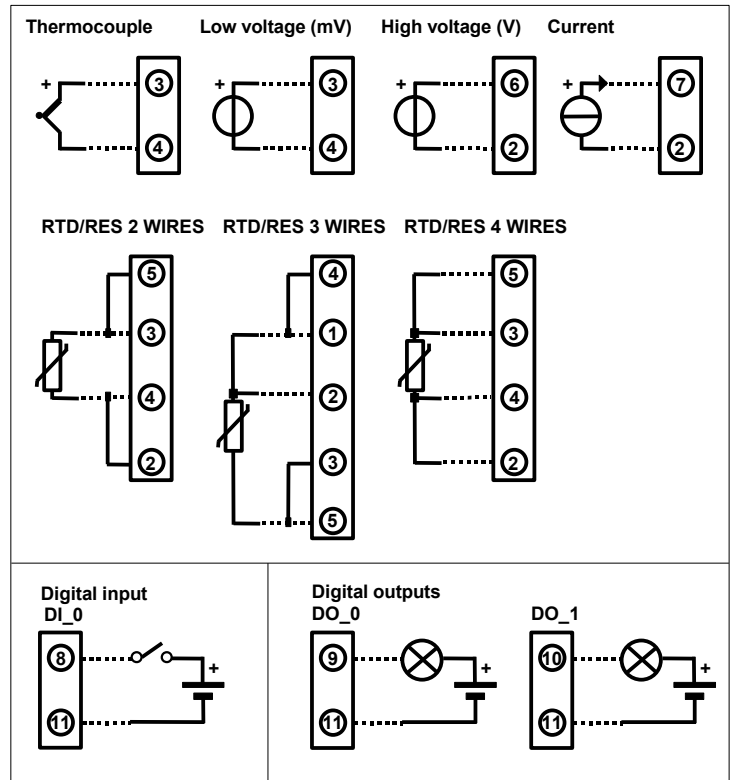

NOTE: digital input, digital outputs and analog input are not isolated.

RS-485 CONNECTIONS

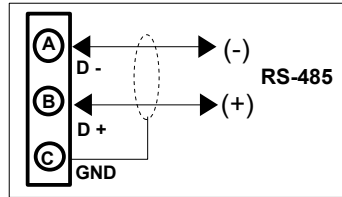

INIT CONNECTION

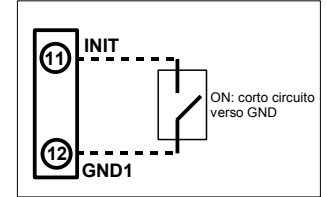

POWER SUPPLY CONNECTIONS

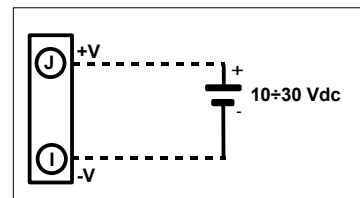

ISOLATION STRUCTURE

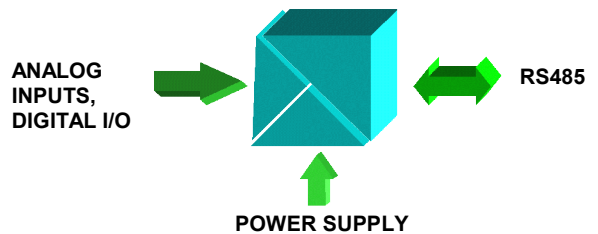

HOW TO ORDER

The DAT 3010 can be supplied in the configuration requested by the Customer. Refer to the section "Technical Specification" for the input type available.

DAT 3010 / Tc K

Input type

■ = Requested
□ = Optional