

**FEATURES**

- Field Bus data acquisition
- Master/Slave communication on RS-485 network
- MODBUS RTU/ASCII protocol
- 4 digital inputs
- 4 relay outputs (2 SPDT + 2 SPST)
- Watch-Dog alarm
- Four ways galvanic isolation 2000 Vac
- High accuracy
- EMC compliance – CE Mark
- In compliance to EN-50022 DIN rail mounting

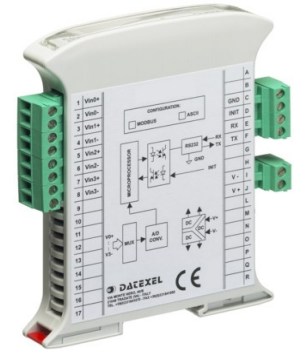

**GENERAL DESCRIPTION**

The device DAT 3130 is able to acquire up to 4 digital inputs and to drive up to 4 relay outputs. The data are transmitted with MODBUS RTU/ASCII protocol on RS-485 network.

To assure safe operation of the system, the device is equipped with two Watch-Dog timers: in case of alarm, the outputs are forced automatically on the safe configuration.

The 2000 Vac galvanic isolation between inputs, outputs, power supply and RS-485 serial line cancels any ground-loop effect noise, allowing the use of the device in worst ambient conditions.

The DAT 3130 is in compliance to the Directive 2004/108/EC on the electromagnetic compatibility.

The DAT 3130 is housed in a rough self-extinguishing plastic enclosure of 22.5 mm thickness, suitable for EN 50022 standard DIN rail.

**COMMUNICATION PROTOCOLS**

On the DAT3000 modules are implemented the following communication protocols:

**MODBUS RTU/ASCII Protocol:** one of the most used standard communication protocol; it permit to interface the modules of DAT3000 series directly to the greater part of PLC and SCADA software available on the market. For communication setting, refer to the User manual.

**OPERATING INSTRUCTIONS**

Before to install the device, please read carefully the "Installation instructions" section.

If the correct configuration of the device is unknown, could be impossible to establish a communication with the device; connecting the INIT terminal to the GND terminal, when the devices is power-on, it goes automatically to the default configuration (see the Operating Manual).

Connect the power supply, the serial bus and the I/O signals as shown in the "Wiring" section.

The "PWR" LED, changes its state in function of the working condition of the device: please refer to the "Light signalling" to verify the correct working of the device.

To make easy the maintenance or the substitution of the device, it is possible the "hot swap" of the terminals.

**TECHNICAL SPECIFICATIONS (Typical @ 25 °C and under nominal conditions)**

<b>Digital Inputs</b>		<b>Power supply</b>	
Channels	4	Supply Voltage	18 .. 30 Vdc
Input voltage (bipolar)		Current consumption	45 mA @ 24 Vdc
OFF State	0 ÷ 3 V	Reverse Polarity protection	60 Vdc max
ON State	10 ÷ 30 V	<b>Isolation voltage</b>	
Impedance	4.7 KΩ	Inputs – RS485	2000 Vac 50 Hz, 1 min.
		Inputs – Supply	2000 Vac 50 Hz, 1 min.
		RS-485 – Supply	2000 Vac 50 Hz, 1 min.
<b>Digital Outputs</b>		<b>Temperature &amp; Humidity</b>	
Channels	4	Operating Temperature	-10°C .. +60°C
Type	n° 2 SPDT relays n° 2 SPST N.O. relays	Storage Temperature	-40°C .. +85°C
Switching power (max.)		Non-condensing Humidity	0 .. 90 %
2 A @ 250 Vac ( resistive load ) per contact		<b>Enclosure</b>	
2 A @ 30 Vdc ( resistive load ) per contact		Material	self-extinguishing plastic
Minimum load	5Vdc , 10mA	Mounting	EN-50022 DIN rail
Max. Voltage	250Vac (50 / 60 Hz) , 110Vdc	Weight	about 210 g.
<b>Sample time</b>	5 ms	<b>EMC ( for industrial environments )</b>	
<b>Data Transmission (asynchronous serial)</b>		Immunity	EN 61000-6-2
Baud rate	up to 38.4 Kbps	Emission	EN 61000-6-4
Max. Distance	1,2 Km – 4000 ft.		

## INSTALLATION INSTRUCTIONS

The device DAT 3130 is suitable to be mounted on DIN rail, in vertical position. For a correct working and a long life of the device, read the following indications.

**In case of the devices are mounted side by side, please leave about 5mm between in the following situations:**

- Temperature in the cabinet higher than 45 °C and high supply voltage (>27Vdc).

Avoid to place raceways or other objects which could obstruct the ventilation slits. It is suggested to avoid that devices are mounted above appliances generating heat; their ideal place should be in the lower part of the panel.

Avoid to install the devices in a site where vibrations are present.

It is recommended to use shielded cable for connecting signals. The shield must be connected to an earth wire provided for this purpose. Moreover it is suggested to avoid routing conductors near power signal cables.

## CABLING

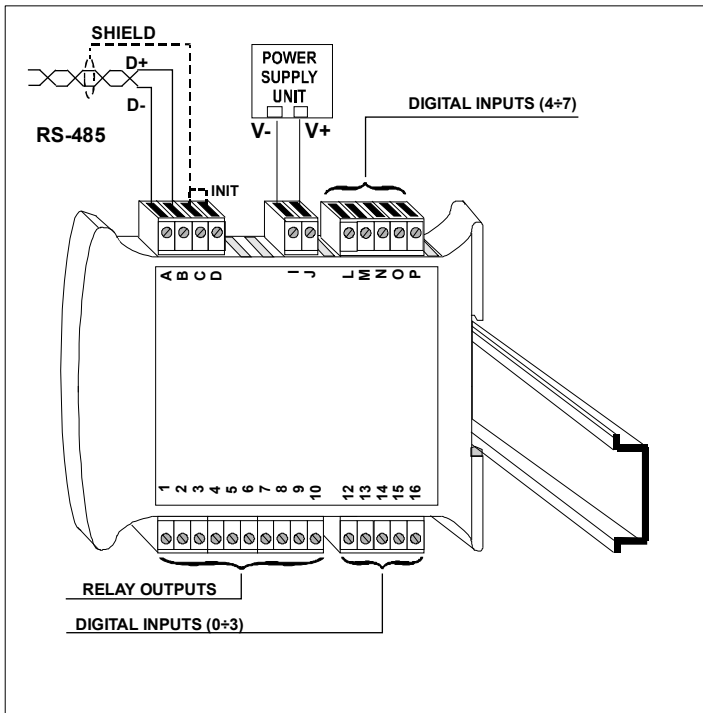

## LIGHT SIGNALLING

LED	COLOUR	STATE	DESCRIPTION
PWR	GREEN	ON	Device powered
		OFF	Device not powered or wrong RS-485 connection
		RAPID BLINK	Communication in progress (the blink frequency depends to the Baud-rate)
		SLOW BLINK	~1 sec. - Watch-Dog Alarm condition

## MECHANICAL DIMENSIONS (mm)

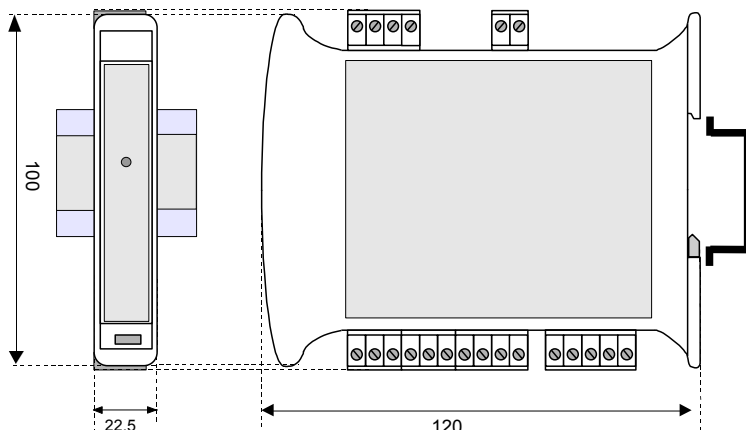

## WIRING

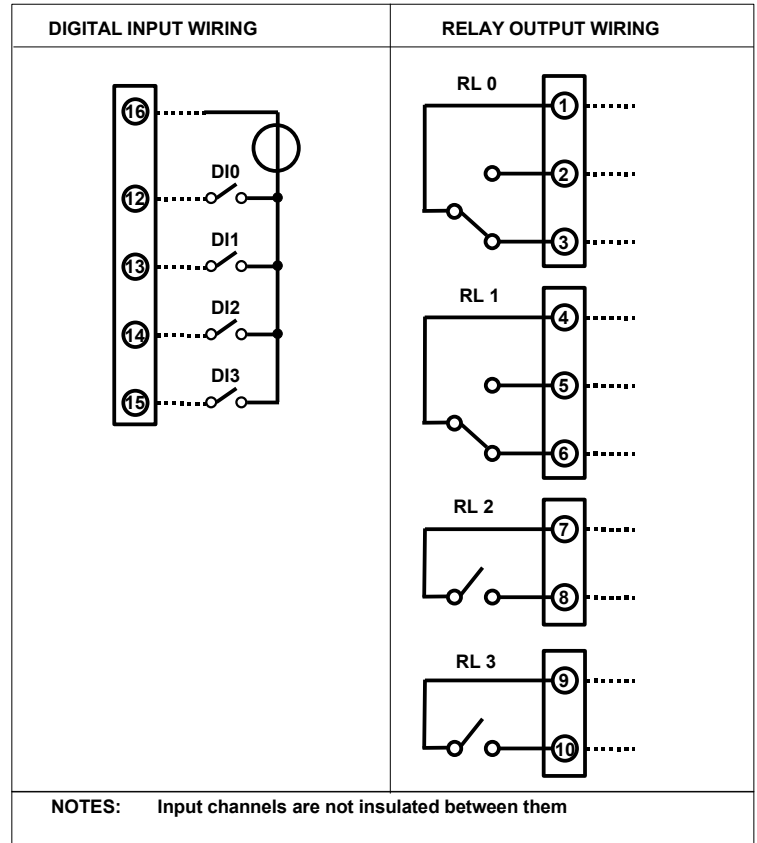

## RS-485 NETWORK WIRING

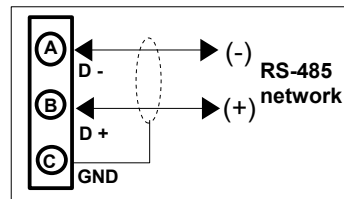

## INIT WIRING

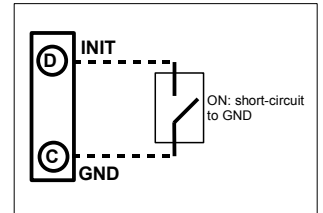

## POWER SUPPLY WIRING

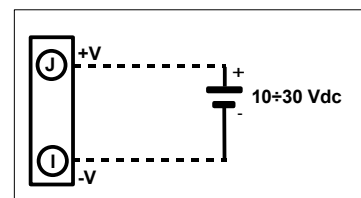

## ISOLATION STRUCTURE

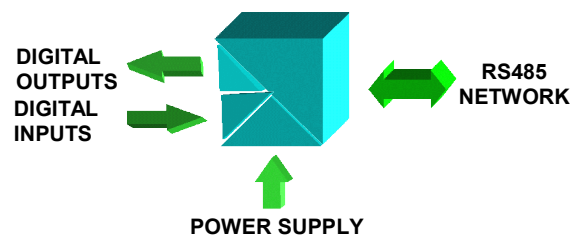

## HOW TO ORDER

DAT 3130

■ = Mandatory  
□ = Optional